

# Spatial Information Structure Modeling for an Effective Management of an Indoor Hazardous Material

Jisung KIM, Hongsic YUN and Minkyu YOUM, Republic of Korea

**Key words:** Hazardous Material Management, Indoor Spatial Information, Toxic Gas, Chemical Explosion, GIS

## SUMMARY

Studies have been conducted in order to control the indoor hazardous material. Accidents, however, such as toxic gas effluence, chemicals explosion still occurs due to lack of management. To overcome the disaster, user-friendly management system which controls the information of chemicals was designed based on the spatial information, and the information structure was modeled in the study. The target functions of the model are Data I/O of materials including spatial information, calculating the escape way in emergency and the interactions of other indoor features such as population, digestion facilities. To achieve these purposes, spatial information structure blueprint was designed, and hazardous material data was constructed based on it. As a result, by successfully executing the target function of the model, validity of the system was confirmed.

## 요약

실내 위험물을 통제, 관리하기 위한 연구들은 지속적으로 수행되었다. 그러나 아직도 관리소홀로 인한 독성가스 유출 및 화학물질 폭발사고 등은 끊임없이 발생하고 있다. 이를 극복하기 위해 이번 연구에서는 사용자에게 친숙하며 체계적으로 관리할 수 있는 공간정보 기반의 실내 위험물 관리체계를 제시하고, 그 공간정보 구조를 설계하였다. 이번 연구에서 제시하고자 하는 체계의 기능은 공간정보를 포함한 실내 위험물의 정보 입출력, 실내의 다른 공간정보 요소와의 상호작용(실내 인원정보, 실내 소방설비 등), 긴급상황 발생시 대피경로 및 소방관 진입 경로의 산정에 있다. 이러한 연구 목적을 달성하기 위하여 먼저는 목표기능을 구현하기 위한 공간정보 구조를 설계하고, 그 설계도를 바탕으로 한 공간정보를 구축하였다. 그리고 구축된 공간정보를 이용하여 목표기능을 성공적으로 수행함으로써 그 타당성을 확보하였다.

---

Spatial Information Structure Modeling for an Effective Management of an Indoor Hazardous Material (8242)  
Jisung Kim, Hongsic Yun and Minkyu Youm (Republic of Korea)

FIG Working Week 2016  
Recovery from Disaster  
Christchurch, New Zealand, May 2–6, 2016

# **Spatial Information Structure Modeling for an Effective Management of an Indoor Hazardous Material**

**Jisung KIM, Hongsic YUN and Minkyu YOUM, Republic of Korea**

## **1. INTRODUCTION**

### **1.1 Background**

Accidents by gas explosion and effluence of toxic gas have happened constantly every year, and cause heavy casualties and property loss. To reduce a disaster by indoor hazardous material, a management system in the whole stages such as prevent, preparedness, response, and recovery of disaster based on objective and accurate information is needed. Prevent stage should understand indoor spatial information and chemicals distribution, and should examine normal operation of safety devices to prevent accidents. Preparedness stage should confirm indoor personal information for evacuation and firefighting equipment that is possible to be used on effluence of toxic gas and gas explosion by chemicals. Response stage should minimize damage by calculating evacuation route of indoor people and approach path of fire fighters in time of emergency. Recovery stage should suggest recovery procedure based on assets before an accident.

To realize this systematic management system, structure of database and file in the system is mightily important as much as structure of the system, but there is not much study on this. Therefore, this study is to suggest data structure to manage indoor hazardous material.

### **1.2 Purpose**

The purpose of this study is to design and suggest spatial information structure for a system that is available on the whole stages such as prevent, preparedness, response, and recovery of disaster by indoor hazardous material.

### **1.3 Method**

This study suggested functions to manage indoor hazardous material effectively, and designed spatial information structure needed to realize the functions. As constructing database based on the designed data structure and realizing target functions set at the initiatory stage, validity of the structure was revealed.

## **2. STUDY AREA**

Requirements of target area to conduct this study successfully are as follows.

---

First, various hazardous materials should exist within doors. Second, information to manage hazardous material should exist. Third, it should be easy to acquire indoor spatial information. Fourth, there should be many people indoors, and it should be easy to acquire information of indoor people. Therefore, this study selected the Second Engineering Building of SungKyunKwan University as an object area of study. There are all sorts of laboratories such as new materials engineering laboratory and chemical engineering laboratory and all sorts of chemicals in the Second Engineering Building, and it is easy to acquire information to manage hazardous material. In addition, it is easy to acquire indoor spatial information through a blueprint, and to acquire data through an on-the-spot survey. Lastly, classroom except for laboratory exists in the Second Engineering Building, and the number of students by classes can be understood through school administration information. Through this, it is possible to understand information of indoor people. Figure 2.1 shows map and picture of the Second Engineering Building of SungKyunKwan University as a study area.



**Figure 2.1 The Second Engineering Building of SungKyunKwan University as a Study Area**

### **3. SETTING THE FUNCTION TO REALIZE**

Functions this system is to realize are divided into data display function and data analyzing function. Data display function is to check present condition of management such as indoor hazardous material and firefighting equipment, and data analyzing function is to help decision making in prevent, preparedness, response, and recovery stages of disaster based on constructed data.

#### **3.1 Data Display Function**

##### **3.1.1 Indoor Spatial Information Display by Floor**

Unlike external feature structure, indoor structure is divided into several floors. It is difficult for data structure used to existing 2D map expressing external spatial information to express

---

indoor spatial information. Therefore, the purpose of this study is to express indoor spatial information efficiently by floors, by improving this data structure.

### 3.1.2 Time-series Spatial Information Display

Amount of indoor hazardous material, distribution of indoor people, and arrangement of firefighting equipment can vary with time. To manage hazardous material in real time, information varying with time is reflected, so spatial information at particular moment should be checked(Kang, 2014). Therefore, the purpose of this study is to realize spatiotemporal information by adding information related to time on to spatial information, and to realize information of indoor hazardous material at particular moment.

### 3.1.3 Related Information Display

All sorts of information are needed for decision making and analysis on indoor hazardous material. In case of chemicals, all sorts of data such as toxic status, ignition point, and viscosity are needed. In case of firefighting equipment, information such as firefighting ability and management cycle is needed. This study is to realize a function combining and expressing this external information.

## **3.2 Data Analyzing Function**

To prepare a disaster by indoor hazardous material, accurate diagnosis and analysis on a disaster based on constructed data are needed. Spatial information structure suggested by this study enables risk analysis on risk by indoor hazardous material and path analysis for calculation of evacuation route in time of emergency.

### 3.2.1 Risk Analysis

Risk Analysis deals with the use of available information to estimate the risk caused by hazards to individuals or populations, property of the environment(Westen, 2009). Figure 3.1 shows a concept of a risk analysis. To prepare a disaster by indoor hazardous material, vulnerability should be judged based on location of hazardous material, density of indoor population, and arrangement of firefighting equipment, and a step to reduce damage in a vulnerable area should be taken. This study designs spatial information structure for a risk analysis with hazardous material, indoor personnel information, and firefighting equipment.

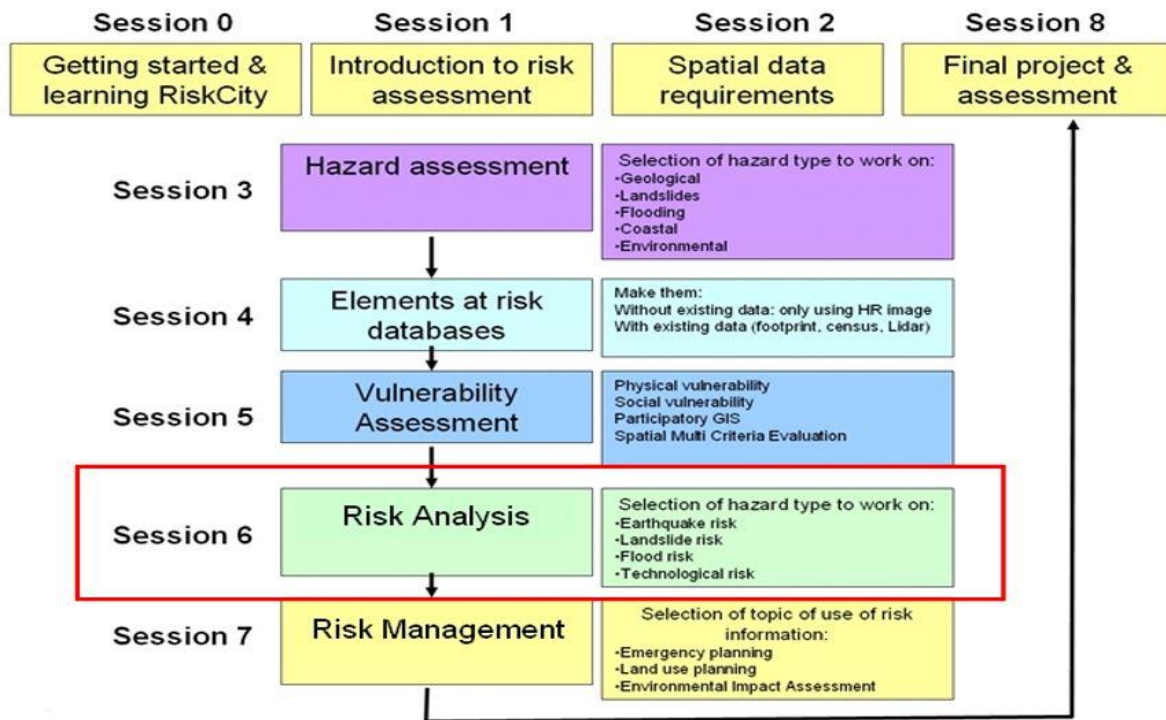

Figure 3.1 Basic Concept of Risk Analysis. (Westen, 2009)

### 3.2.2 Network Analysis

Quick evacuation of indoor people is important to minimize casualties on fire by chemicals and toxic gas leak. To calculate efficient evacuation route of indoor people, various factors such as arrangement of indoor features, distribution of indoor people, and birthplace of chemical disaster should be complexly considered. Spatial information structure suggested by this study is designed to calculate fire suppression route of fire fighters in time of emergency and evacuation route of indoor people.

## 4. FUNCTION-DATA MODELLING

### 4.1 Modelling for Floor Separation

Sometimes, indoor structure is made by single floor, but most buildings including the object area of study are made by more than two floors. Floor division is important to browse or analyze spatial information. Therefore, this study divides into indoor and external on the basis of location including spatial information, and shows each floor by giving PhyscLvl Field that is altitude division attribute. Figure 4.1 shows a division concept of spatial information by floors using PhyscLvl.



**Figure 4.1 Example of Division by Floors using PhyscLvl Attribute**

## 4.2 Modelling for Time-series Map Display

Indoor fire fighting equipment does not vary with time, but indoor hazardous material and people information vary with time. To reflect this time variation, expiration date of feature is showed by giving start time and end time that feature is valid(Kim, 2016). Figure 4.2 shows feature change with time and example to give attribute.

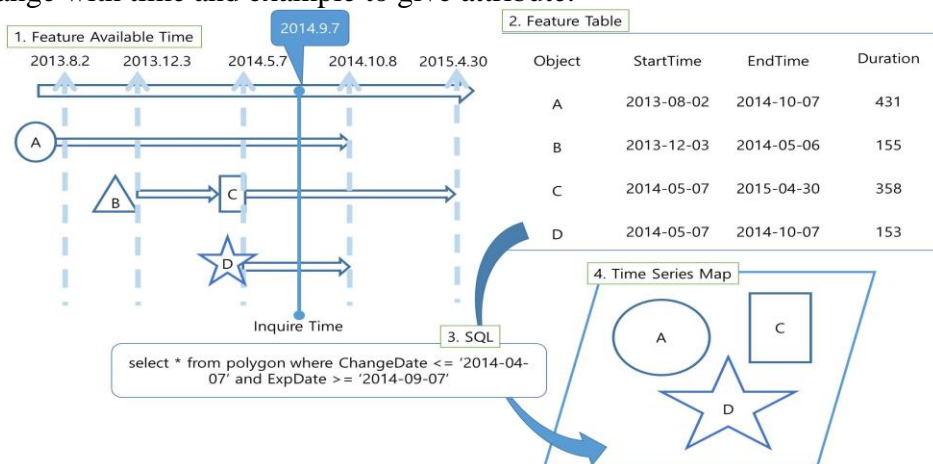

**Figure 4.2 Time-series Map Concept using Time Related Attribute. (Kim, 2016)**

### 4.3 External Data Link

A variety of information is needed to manage indoor hazardous material effectively. However, there are shortcomings to construct by including a variety of external information in spatial information. First, physical size of spatial information grows larger, and unnecessary storage space is needed. Second, only information included in spatial information can be used, so the use of spatial information is limited(Hwang, 2014). Therefore, to overcome this limit, this study uses a concept of relational database, so enables to have structure connected with external information. Indoor space has room number, and is connected with hazardous material and present condition of management by using this number.

### 4.4 Entity-Relationship Diagram

Improving existing spatial information structure of Kim(2015), if discussed structures are showed by a concept of relational database, it is as Figure 4.3.

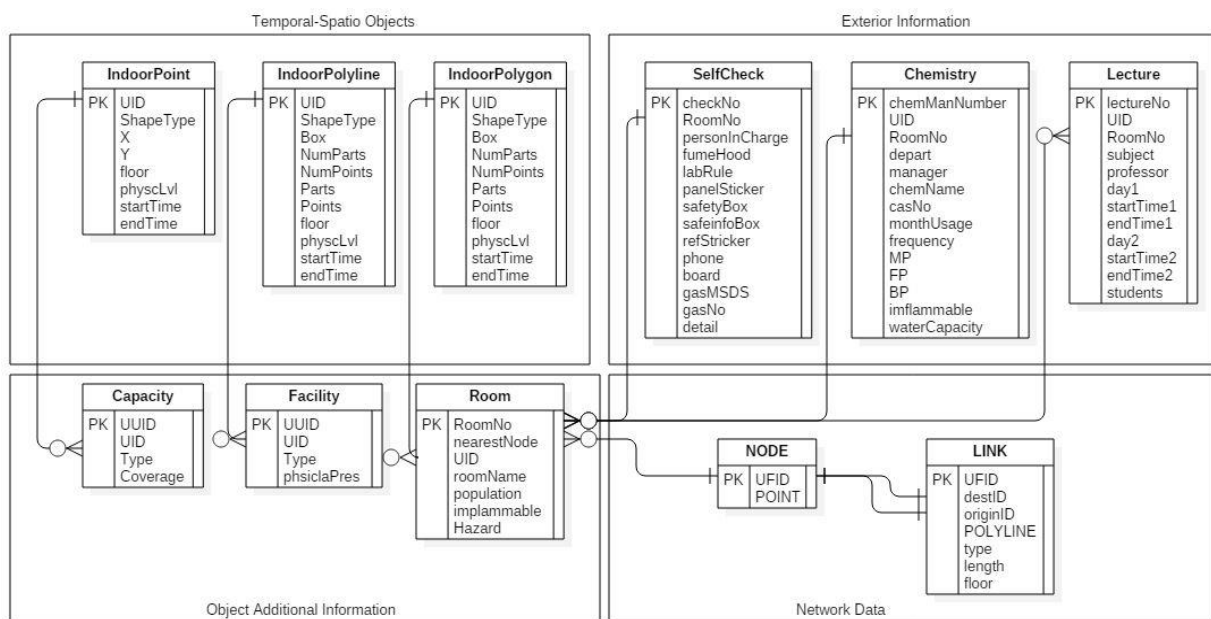

**Figure 4.3 ER Diagram of Indoor Spatial Information Structure suggested by This Study**

## 5. DATABASE CONSTRUCTION

Database is constructed based on the designed database structure. First of all, indoor features are divided into point, polyline, and polygon, and then are constructed. After that, attribute information such as hazardous material existed indoors, present condition of firefighting equipment, and present condition of lecture is input and connected.

## 5.1 Indoor Feature Construction

### 5.1.1 Polygon Feature Construction

Indoor hallway and laboratory can be expressed by polygon feature. Polygon features should satisfy topological regulations by floors. If each space of the Second Engineering Building is constructed by polygon feature and is expressed by floors, it is as Figure 5.1.

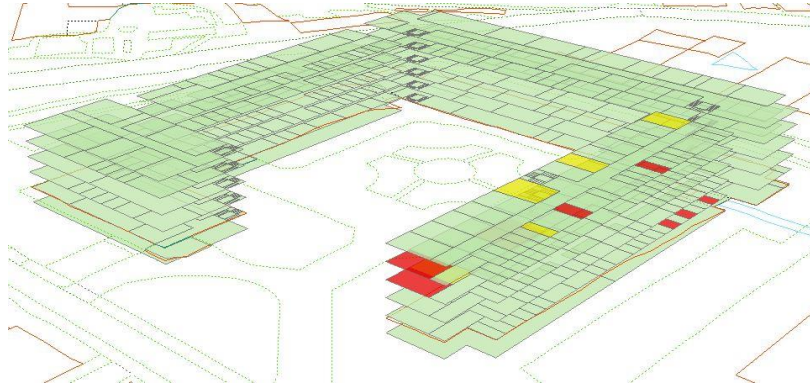

**Figure 5.1 Polygon Feature Construction**

### 5.1.2 Polyline Feature Construction

Spatial feature connecting and separating each indoor space such as door and wall can be expressed as polyline feature. Polyline features such as firewall and door play an important role to calculate the best evacuation route in time of emergency. Figure 5.2 expresses polyline feature of the constructed target area by floors.

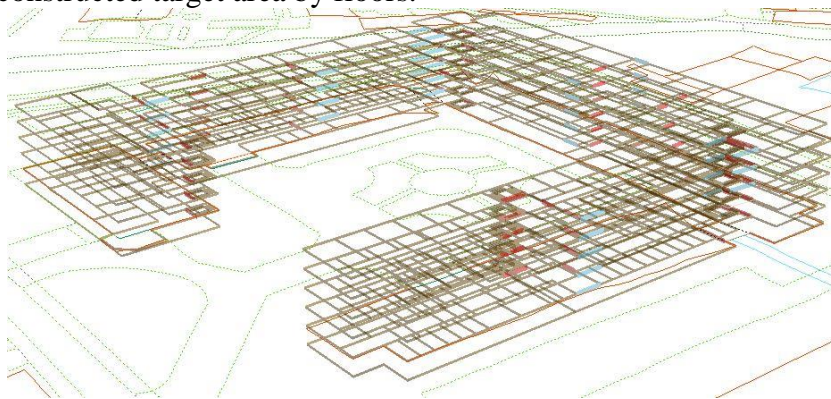
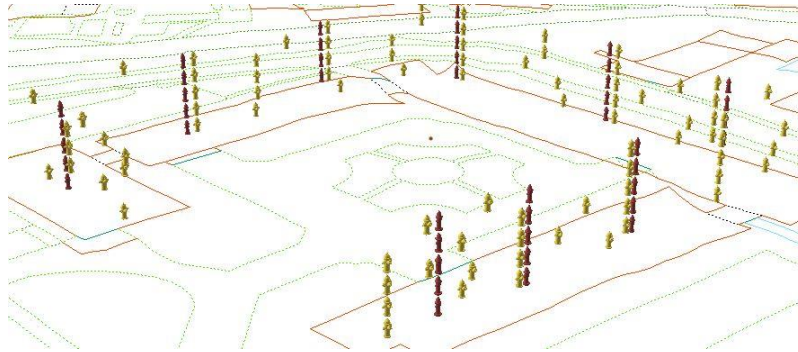

**Figure 5.2 Polyline Feature Construction**

### 5.1.3 Point Feature Construction



The location of emergency resources such as fire extinguisher, fire hydrant, and sprinkler can be expressed by point feature. Figure 5.3 constructs point features so divides altitude.



**Figure 5.3 Point Feature Construction**

## **5.2 Input and Connection of Attribute Information**

### **5.2.1 Management Information Hazardous Material**

Management information of indoor hazardous material can be easily accessed through hazardous material management database of SungKyunKwan University. This information includes present condition of management of laboratory dealing with hazardous material and information of hazardous material. Present condition of management of laboratory includes information of protector status, manager, status board, and fume hood, and present condition of hazardous material includes information of CAS No. of material used in each place, name of material, frequency of usage, and monthly amount used. This information can express the location through room number.

### **5.2.2 Firefighting Equipment Construction**

There is various firefighting equipment such as fire extinguisher, fire hydrant, and storage box of firefighting equipment indoors, damage of chemical disaster can be reduced by using these equipment properly. This study establishes information of emergency resources by understanding location and sorts of firefighting equipment in site.

### **5.2.3 Indoor Personnel Information Construction**

Indoor personnel information can be divided into floating population and fixed population. A fixed population means people commuting a daily moment at a regular hour such as researcher working in professor's room, desk clerk, and professor. The number of people taking a class in the school building varies with sort and fixed number of people, and varies with time. Therefore, a fixed population is given to each spatial feature as attribute value and

then is showed, and the change of a floating population is showed with time by using lecture information of school integrated management system.

## **6. APPLICATION**

Practical management system is realized to secure validity of constructed spatial information. It is confirmed whether target functions set in the early part are rightly conducted, and the study is to find something else to improve. Early target functions to conduct are inquiry of hazardous material by floors and time, risk analysis, and route guidance. Through these functions, it is confirmed whether the designed spatial information structure works rightly.

### **6.1 Inquiry of Spatial Information by Floors and Time**

It is confirmed whether an inquiry function of spatial information by floors and time, the most important spatial information reading function, works normally. Figure 6.1 shows an inquiry result by floors and time through the inquiry toolbox developed to realize the function. Indoor population and hazardous materials are displayed based on selected floor and time. Information of object selected also shown such as hazardous material name, CAS number, monthly usage, etc.

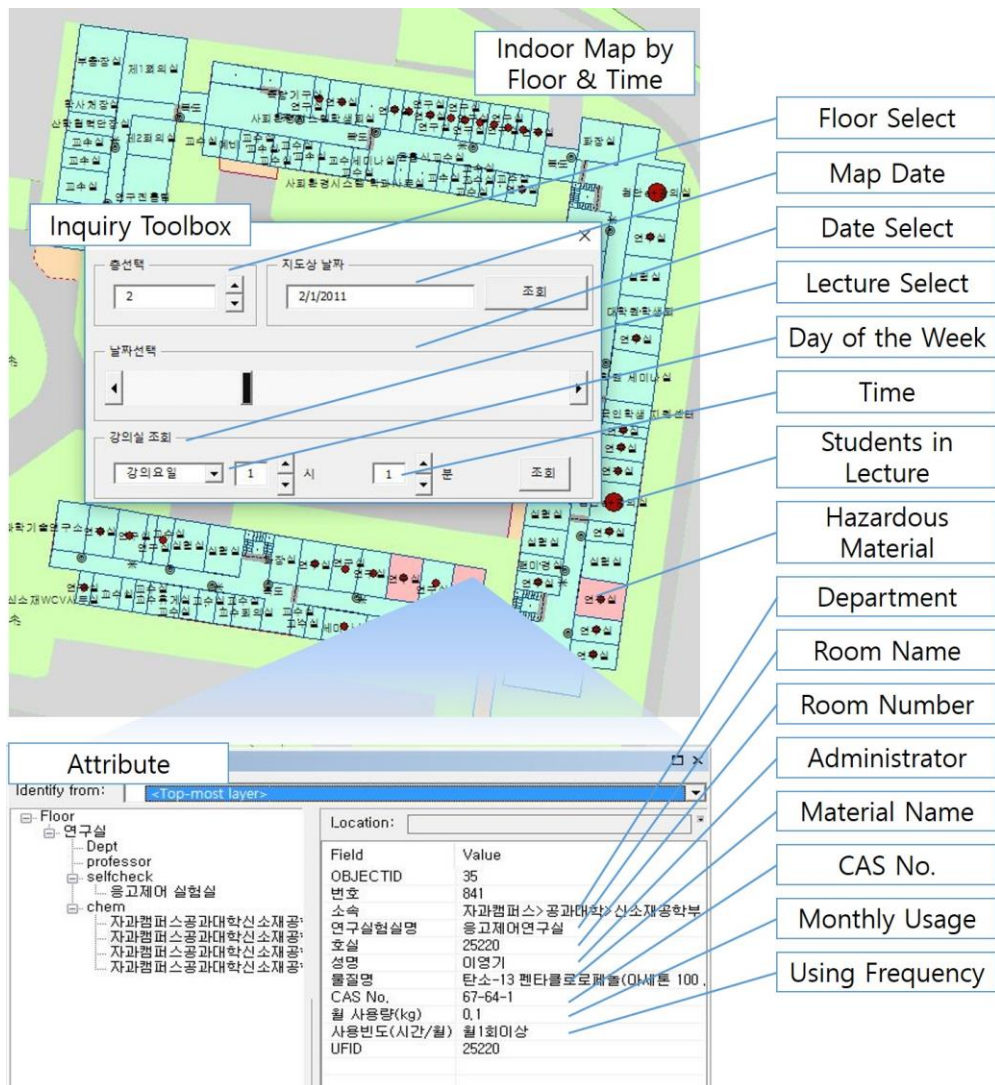

Figure 6.1 Inquiry Function Realization by Floor and Time

## 6.2 Risk Analysis

To reduce damage of disaster by indoor hazardous material, hazard by chemicals, vulnerability, and capacity are synthetically understood, and complementary measure of area whose risk is high should be presented. This study conducts a risk analysis based on suggested data structure, so understands applicability of structure. The study does a risk analysis by using a method of formula 6.2 suggested by Cees Van Westen(2009).

$$\text{Risk} = \text{Hazard} \times \text{Vulnerability} / \text{Capacity}$$

6.2

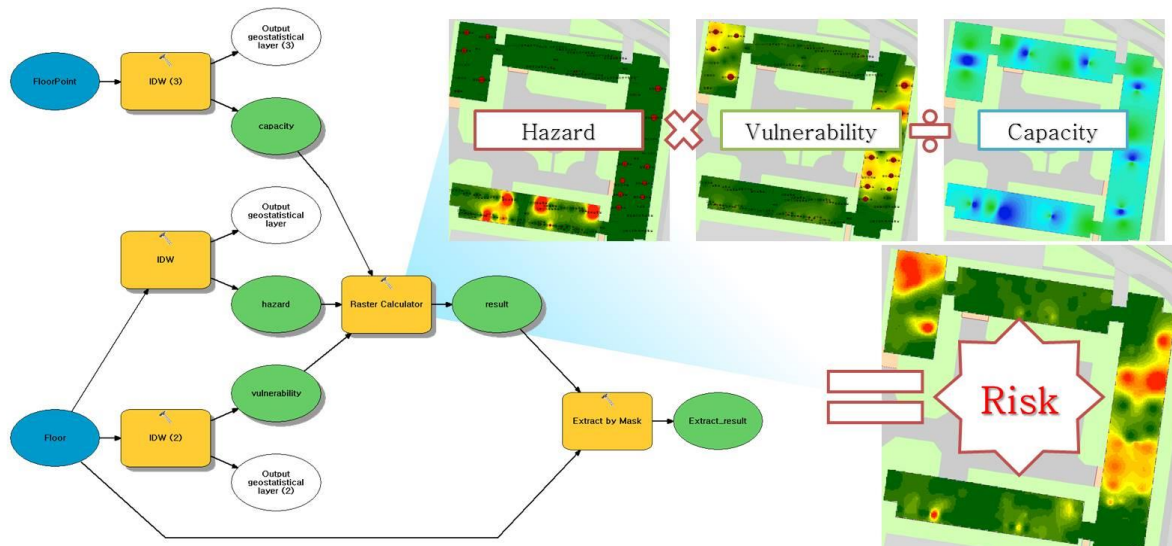
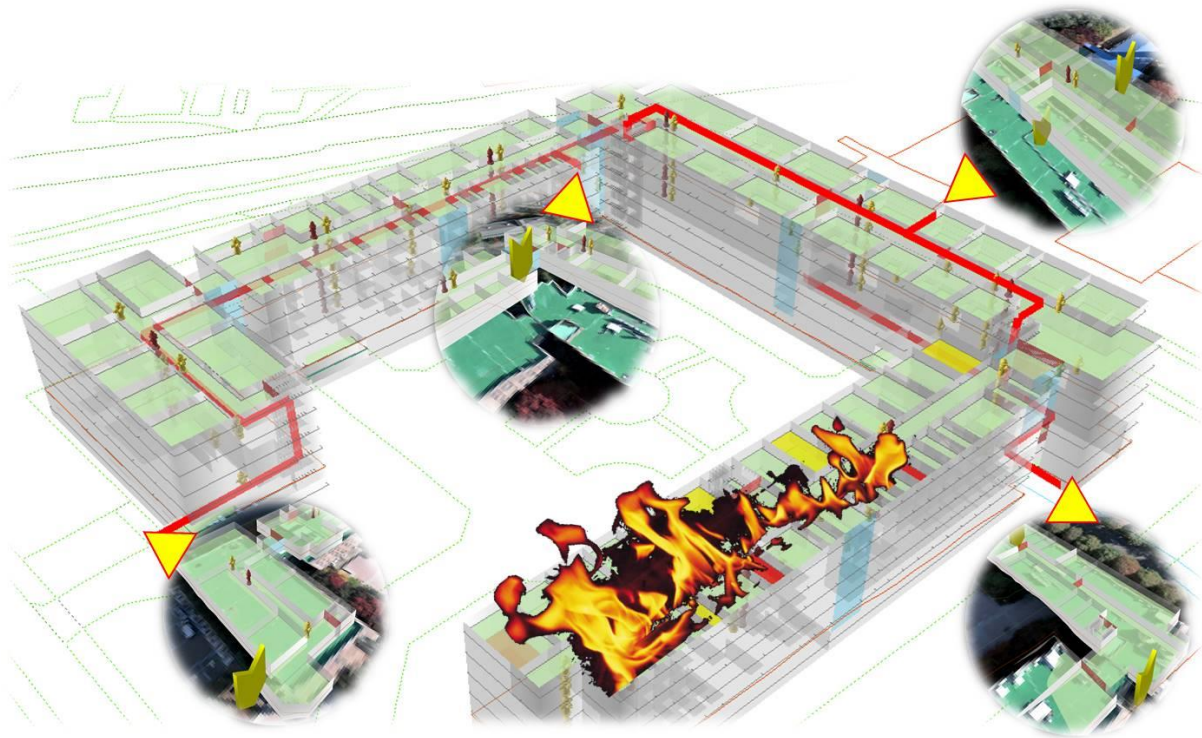

**Figure 6.3 Risk Analysis conducted by Spatial Information Structure suggested by This Study**

Figure 6.3 shows a flow chart proceeding a risk analysis with data structure suggested by this study and the result. There are hazard distribution, vulnerability distribution, and capacity distribution of firefighting equipment within the same floor, and distribution of risk considering this synthetically is showed.

### 6.3 Route Guidance

When a chemical accident happens at given spot, measures to prevent diffusion of chemical accident are needed, and fire fighters should suppress fire quickly by using indoor and outdoor firefighting equipment. Spatial information structure suggested by this study gives transit division such as door and wall to attribute value, and the best route can be calculated by reflecting this in a route analysis. Figure 6.4 shows a result calculating the best suppression route of fire fighters that uses transit division.



**Figure 6.4 Calculation of the Best Fire Suppression Route on Fire in Particular Area**

## **7. CONCLUSION AND FUTURE DIRECTION IN RESEARCH**

### **7.1 Conclusion**

This study designs indoor spatial information structure to manage indoor hazardous material efficiently. Indoor spatial information structure should be designed to understand conditions of indoor space, hazard, and people by floors and time, and should be variously used by combining with a variety of external information. To realize this, attribute related to and floor division attribute are given to spatial information, and this structure is designed by setting Key connected with external information. It is confirmed that designed indoor spatial information can conduct various functions such as not only information query by floors and time but also risk analysis and route search. Through this, design validity is secured.

### **7.2 Limit of Research and Future Direction in Research**

The scope of this study is limited to indoor spatial information structure. Therefore, limits of study related to this are as follows. First, it is difficult for this to be applied to the outside. Second, this study is a study of spatial information structure, so an additional study of algorithm to realize functions is needed. Lastly, spatial information structure suggested by this

study is fully available and valid, but it is unknown whether this structure is the optimization structure in an aspect of use.

Therefore, future direction in research should modify and compensate this. An aspect of spatial information structure can be combined with a concept of SOLAP, and a study of various uses is needed in an aspect of disaster-prevention.

## REFERENCES

Hwang. J. S., Yun. H. S, Yoo. J. Y., Cho. S. H., Kang. S. C., 2014, Development of Hybrid Spatial Information Model for National Base Map, Journal of the Korean Society of Surveying, Geodesy, Photogrammetry and Cartography, Vol. 32, No. 4-1, pp.335-341

Kang. S. C., Yoon. H. S, Kim. J. S., Hwang. J. S., 2014, Study of Time Series DB Design in Digital Map for Feature History Management, Korean Society of Civil Engineers, pp.1685-1686

Kim. C. W., 2016, Development of Spatio-temporal Data Model for the Spatial information Production, p.57

Kim. J. S., 2015, Indoor Hazardous Material Management Using Multi-dimensional Spatial Information Structure, p.28

Westen. C. V., 2009, Multi-hazard Risk Assessment, Distance Education Course Guide Book, UNU-ITC DGIM, p.6-2

## BIOGRAPHICAL NOTES

Bachelor's Degree in Civil and Environmental Engineering-2013

Master's Degree in Civil, Architectural and Environmental System Engineering-2015

## CONTACTS

Jisung KIM  
SungKyunKwan University  
2066,Seobu-ro, Jangan-gu, Suwon-si  
Gyeong Gi-do  
KOREA  
Tel. +82-031-290-7536  
Email:jskim6687@paran.com  
Web site: <http://geo.skku.ac.kr/>